

Frontansicht / Vue de face
Vista frontale / Front view

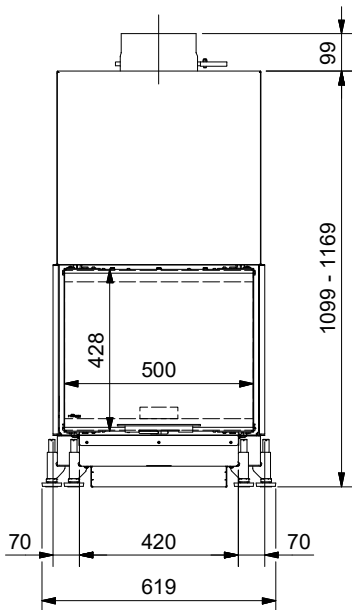

Seitenansicht / Vue de coté
Vista laterale / Side view

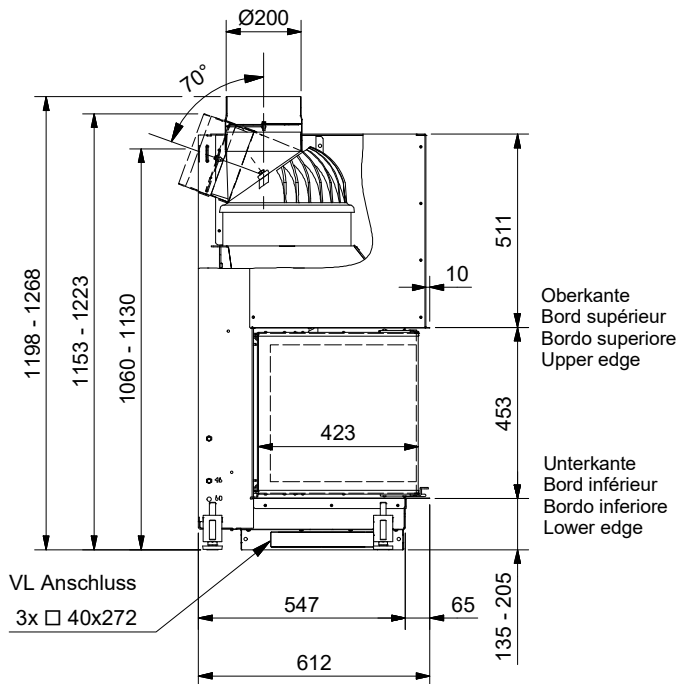

Aufsicht / Vue de haut
Vista dall'alto / View above

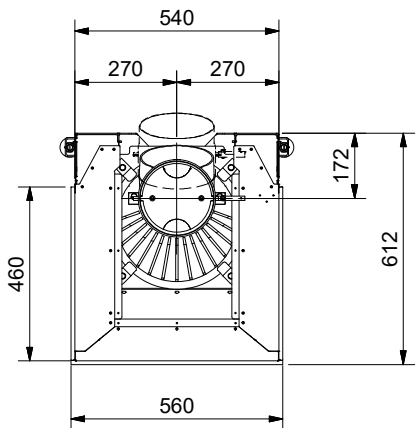

Grundriss Feuerstelle / Coupe sur foyer
Sezione al piano fuoco / Layout fireplace

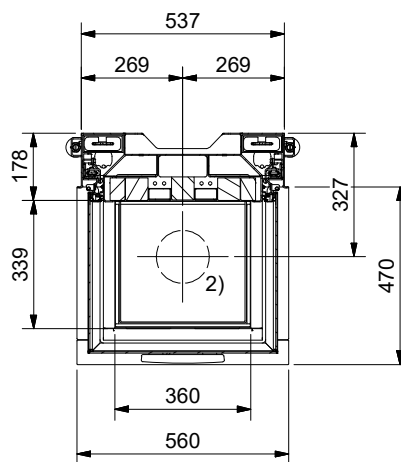

2) Ø 150 mm Verbrennungsluft / Air de combustion / Aria di combustione / Combustion air

Allgemeintoleranz / Tolerance générale / Tolleranza generale / Tolerance general ± 2 mm

Detailansichten durch Zoom-Funktion auf dem elektronischen pdf-Massblatt ersichtlich. Download unter www.ruegg-cheminee.com.
La vue détaillée est visible par la fonction zoom sur la fiche de mesure pdf. Download voir sous voir sous www.ruegg-cheminee.com.
La vista dettagliata é resa possibile tramite la funzione "Zoom" sulla scheda tecnica in pdf. Scaricabile dal sito www.ruegg-camini.it.
Detailed views of zoom function on the electronic PDF datasheet apparent. Download at www.ruegg-cheminee.com.

Alle Masse in mm! Massänderungen vorbehalten / Dimensions en mm! Sous réserve de modifications / Tutte le misure indicate sono in mm! Con riserva di modifica / All dimensions in mm! Mass change without notice

Typ **RIII 45x56x46 Gen.1**

Art. Nr. 11.40.2016-03720

Status Freigegeben

Massblatt
Fiche de mesure
Scheda tecnica
Dimensional drawing

Masstab
Echelle
Scala
Scale
1:20

ruegg
SWITZERLAND

Rüegg Cheminée Schweiz AG
Studbachstrasse 7
CH-8340 Hinwil

Tel. : +41 (0)44 938 58 58
Fax. : +41 (0)44 938 58 38
www.ruegg-cheminee.com

Projektionsmethode

Zeichnungs Nr.

2017-00644

Revision

1

100 cm
80 cm
60 cm
40 cm
20 cm
0