



# Flex-Line

OPERATING MANUAL



# 1. Table of contents

1.	Table of contents .....	3
2.	Editorial .....	5
2.1.	Purpose of the manual .....	6
2.2.	Keeping the manual .....	6
2.3.	Other applicable documents .....	6
2.4.	Safety information .....	6
3.	Information about the product .....	8
3.1.	Type test .....	8
3.2.	Requirements for installation and operation .....	8
3.3.	Intended use .....	8
3.4.	Temporary-burning fireplace .....	8
3.5.	Instruction by a specialist installer .....	8
3.6.	Multiple use of the flue gas system .....	9
3.7.	Technical data .....	9
3.8.	Firebox lining with Thermobrikk® .....	11
3.9.	Type plate .....	12
3.10.	Operating elements .....	13
3.11.	Fire door .....	14
3.12.	Air regulator .....	15
3.13.	Flue gas valve .....	15
3.14.	Valves for combustion air/convection air .....	16
3.15.	Air grille .....	16
3.16.	Fan .....	17
4.	Information about safety .....	18
4.1.	Safety spacing in the heat-radiation area .....	18
4.2.	Air grille .....	18
4.3.	Precoat .....	18
4.4.	Fire door .....	19
4.5.	Combustion air .....	19
4.6.	Responsibility to inspect .....	19
4.7.	Damage to the system .....	19
4.8.	Changes to the system .....	19

4.9.	Care and maintenance.....	19
4.10.	Chimney fire .....	20
5.	Fuel .....	21
5.1.	Forbidden fuels .....	21
5.2.	Flammable and explosive materials .....	21
5.3.	Firewood sizes.....	21
6.	Information about operation .....	22
7.	Commissioning .....	23
7.1.	Complete combustion .....	23
7.2.	Reduce harmful substances.....	24
7.3.	Firing module .....	24
7.4.	Putting on wood .....	25
7.5.	Effect of weathering .....	25
7.6.	Preparing the system .....	26
7.7.	Fire .....	26
7.8.	Loading in fuel .....	26
7.9.	Firing with full load .....	27
7.10.	Firing with a light load .....	27
8.	Closing down.....	28
8.1.	Malfunctions .....	28
9.	Information about care and maintenance.....	30
9.1.	Cleaning .....	31
9.2.	Checks .....	33
9.3.	Maintenance .....	33
9.4.	Repair.....	34
9.5.	Spare parts.....	34
9.6.	Warranty conditions .....	34

## 2. Editorial

### The fire is part of the family



Matthias Rüegg, CEO of the Rüegg Group

***Creativity***

***Appreciation***

***Passion***

People often ask me what makes Rüegg so successful. That's a good question, which I am always happy to answer. There are three things:

First there's *creativity*. That is the desire always to look at things in a different light and search for and risk something new, unknown and unique. For example, Rüegg discovered the firebox that can be sealed with a pane of glass and therefore created the basic conditions for efficient, clean, living room fires. There have been thousands of larger and smaller flashes of genius, from which a living room fire with the unique qualities of Rüegg have ultimately emerged.

Secondly, the *appreciation* that runs as a thread through all of our activities. But first and foremost, there is the appreciation of our customers, employees and business partners, without whom we would not exist. Then there is also the appreciation of natural resources and the careful treatment of our natural basis for life. It is not just the large but also the very small things that shape our prominence and thanks to which we can stand behind our products with complete conviction.

The third and equally important catchword is *passion*. It is the driving force to build systems for our customers that give satisfaction for a very long time thanks to their quality, long service life, ease of operation and reliability. Passion is also the desire always to have our finger on the pulse. It simply gives us pleasure to surprise the market with novelties and clever innovations time and again.

Creativity, appreciation and passion. That is the foundation our success is based on. That is what all my staff, and indeed, I myself stand for.

And now I hope you will enjoy reading and find much inspiration. I am certain that a few Rüegg sparks will also jump out at you.

Yours, Matthias Rüegg

## 2.1. Purpose of the manual

This manual is aimed at operators of a fireplace. It contains important information for safe and sustainable operation, as well as for the care and maintenance of your fireplace.

Read this manual through carefully before starting the first fire. No special previous knowledge is required.

## 2.2. Keeping the manual

Keep this manual close to your fireplace. You can read through it at a later date, if necessary. Other useful information and a copy of this manual can be found on the Internet at:

**[www.ruegg-cheminee.com](http://www.ruegg-cheminee.com)**

## 2.3. Other applicable documents

Follow applicable documents for components of third-party manufacturers (e.g. fans, dampers etc.) that are installed in your fireplace.

## 2.4. Safety information

Carefully read the generally applicable safety information in *Section 4*.

The warnings embedded in the text will make you specifically aware of potential hazards when operating and maintaining the fireplace. The warning information is clearly marked and divided into three steps:

### Step 1

Indicates a potential hazard. Failure to observe or take remedial action may result in *serious injury!*

Example:

Example:

---

**▲ WARNING**



### **Risk of fire!**

Flammable materials may ignite when exposed to naked flames and hot surfaces.

- Do not store combustible materials close to the fireplace
  - Keep a safe distance from the fireplace
-

## Step 2

Indicates a potential hazard. Failure to observe or take remedial action may result in *minor injury!*

### Example:

---

#### **VORSICHT**



#### **Hot surfaces!**

Contact with hot surfaces may result in severe burns.

- Do not touch hot surfaces
  - Use safety gloves
  - Always supervise children
- 

## Step 3

Indicates a potential hazard. Failure to observe or take remedial action may result in *damage to the product!*

### Example:

---

#### **HINWEIS**

#### **Ceramic glass**

Unsuitable liquids and cleaning agents will damage the surface of the ceramic glass.

- Only use permitted liquids and cleaning agents
  - Follow maintenance information
-

## 3. Information about the product

### 3.1. Type test

Our products are checked for fire safety by an accredited test institute and for compliance with country-specific flue gas emissions. The current versions of the following standards apply to the inspection:

Fireplaces	→	EN 13229
Room heaters	→	EN 13240
Ovens	→	EN 12815

### 3.2. Requirements for installation and operation

Apply to the relevant authority for the necessary licences for installing and operating your system. Obtain operating approval, if necessary, before initial use.

Have your system installed by a specially trained installer. They will ensure that all *valid European, national and local requirements and directives* are met for the installation and operation.

### 3.3. Intended use

Your system consists of a fireplace insert, a surround, an air supply and a flue gas system. The fireplace insert is approved for burning solid mineral fuels, as described in Section 4.1. No other uses are permitted and may result in damage to property or personal injury.

### 3.4. Temporary-burning fireplace

The fireplace insert is tested as a temporary-burning fireplace. You may operate your system with the permitted fuel and maximum permitted fuel quantities without the time restriction.

### 3.5. Instruction by a specialist installer

Have your specialist installer explain your system to you in detail when it is first used. Always contact your specialist installer in the first instance if you have any questions or problems with the system. They know the system in detail and will be able to provide you with expert information.



### 3.6. Multiple use of the flue gas system

Multiple use is where several fireplaces are connected to the same flue gas system. The *fire doors* of all the fireplaces must be *self-closing* to ensure that the flue gases are safely removed.

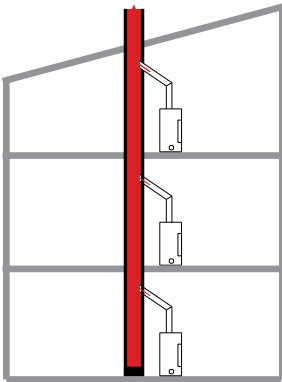

### 3.7. Technical data

The values listed in the following tables either depend on the particular design or were established during a type test in accordance with EN 13229.

		<b>Violino 45x60</b>	<b>Violino 45x80</b>	<b>Violino 55x73</b>
Fireplace (clear opening) H x W	cm	45 x 60	45 x 80	55 x 73
External dimensions H x W x D	cm	111 x 77 x 53	111 x 97 x 53	125 x 89 x 53
Complete weight	kg	220	280	280
Nominal heat performance	kW	8.4	9.2	12.5
Room heat performance	kW	9.2	10.1	13.7
Efficiency	%	84	80	80
Combustion per hour	kg/h	2.6		4.2
CO (rel. to 13 vol. % O <sub>2</sub> )	mg/ Nm <sup>3</sup>	1250	1125	1000
Dust (rel. to 13 vol. % O <sub>2</sub> )	mg/ Nm <sup>3</sup>	11	23	10
Flue gas flow rate (closed)	g/se c	7.9	10.6	12.9
Flue gas temperature (closed)	°C	256	273	304
Minimum pressure head (closed)	Pa	12	12	12
Diameter flue gas outlet	cm	20	20	20
Test in accordance with EN 13229	no.	RRF 29 15 4144	RRF 29 15 4184	RRF 29 16 4303

		<b>Violino 55x98</b>	<b>Violino 65x87</b>
Fireplace (clear opening) H x W	cm	55 x 98	65 x 87
External dimensions H x W x D	cm	125 x 115 x 53	145 x 104 x 53
Complete weight	kg	314	330
Nominal heat performance	kW	14	12.1
Room heat performance	kW	14.8	13.4
Efficiency	%	80	81
Combustion per hour	kg/h	4.4	4.3
CO (rel. to 13 vol. % O <sub>2</sub> )	mg/ Nm <sup>3</sup>	1125	1250
Dust (rel. to 13 vol. % O <sub>2</sub> )	mg/ Nm <sup>3</sup>	22	14
Flue gas flow rate (closed)	g/se c	13.2	12.1
Flue gas temperature (closed)	°C	305	294
Minimum pressure head (closed)	Pa	12	12
Diameter flue gas outlet	cm	20	20
Test in accordance with EN 13229	no.	RRF 29 16 4252	RRF 29 16 4219

		<b>RIII 45x56x46</b>	<b>RIII 45x56x60</b>	<b>RIII 45x56x80</b>
Fireplace (clear opening) H x W	cm	45 x 54 x 46	45 x 54 x 60	45 x 56 x 80
External dimensions H x W x D	cm	111 x 62 x 61	119 x 62 x 75	119 x 62 x 95
Complete weight	kg	180	200	230
Nominal heat performance	kW	8.2	11.7	10.6
Room heat performance	kW	9	12.9	11.7
Efficiency	%	81	83	81
Combustion per hour	kg/h	2.65	3.72	3.47
CO (rel. to 13 vol. % O <sub>2</sub> )	mg/ Nm <sup>3</sup>	1250	875	1250
Dust (rel. to 13 vol. % O <sub>2</sub> )	mg/ Nm <sup>3</sup>	27	20	16
Flue gas flow rate (closed)	g/se c	7.7	9.1	9.6
Flue gas temperature (closed)	°C	303	320	317
Minimum pressure head (closed)	Pa	12	12	12
Diameter flue gas outlet	cm	20	20	20
Test in accordance with EN 13229	no.	RRF 29 17 4485	RRF 29 17 4694	RRF 29 17 4693

		<b>R III 45x80x46</b>	<b>RIII 45x100x46</b>	<b>RIII 55x10x46</b>
Fireplace (clear opening) H x W	cm	45 x 78 x 46	45 x 100 x 46	55 x 98 x 46
External dimensions H x W x D	cm	119 x 86 x 61	98 x 61 x 110	130 x 106 x 61
Complete weight	kg	215	335	277
Nominal heat performance	kW	11.1	11	11.7
Room heat performance	kW	12.2	12.1	12.9
Efficiency	%	82	84	78
Combustion per hour	kg/h	2.58	3.49	3.98
CO (rel. to 13 vol. % O <sub>2</sub> )	mg/ Nm <sup>3</sup>	1125	1250	1250
Dust (rel. to 13 vol. % O <sub>2</sub> )	mg/ Nm <sup>3</sup>	12	10	27
Flue gas flow rate (closed)	g/se c	9.9	8.6	14.9
Flue gas temperature (closed)	°C	305	301	295
Minimum pressure head (closed)	Pa	12	12	12
Diameter flue gas outlet	cm	20	20	20
Test in accordance with EN 13229	no.	RRF 29 17 4621	RRF 29 16 4399	RRF 29 17 4646

### 3.8. Firebox lining with Thermobrikk®

The firebox linings with Thermobrikk® consist of several wall- and floor components. The following images apply to all shapes and sizes of Rüegg fireplaces fitted with Thermobrikk®.

Install the firebox lining in the specified order and dismantle the individual components in the reverse order.

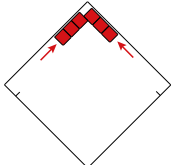

Set up the wall elements in the firebox. Start in the corner of the back and side wall.

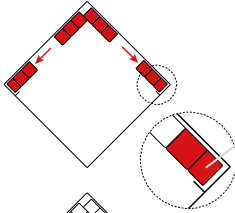

Set up the wall elements in the firebox. Push behind the sheet metal tab in the area of the firebox opening.

Always place the cut-to-size wall elements forwards in the area of the firebox opening!

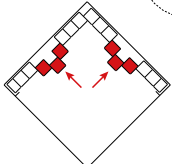

Fill the back and side walls with wall elements. Push wall elements together without any gap.

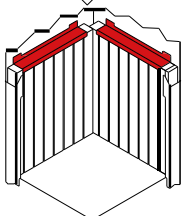

Fasten the mounting bracket to the firebox wall with screws.

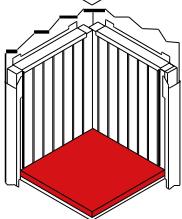



Place all floor elements carefully on the floor of the sheet metal. Evenly distribute any lateral play between the floor elements.

### 3.9. Type plate

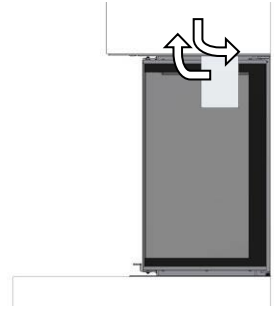
Important performance data is captured on the type plate. The type plate can be found on the right-hand side of the appliance on the inside of the lining.



Lateral thermal insulation / Isolation latérale:	XX cm	mineral wool / Fibre minérale
thermal insulation behind / Isolation arrière:	XX cm	$\rho \geq 100 \text{ kg/m}^3; \lambda \leq 0.035 \text{ W/(mK)}$
thermal insulation underneath / Isolation dessous:	XX cm	$T \geq 750^\circ \text{C}$
Minimum safety spacing from combustible materials / Distance de sécurité minimale aux éléments inflammables:	XXX cm	
Nominal heat performance / Puissance nominale:	XX.X kW	
thermal performance range / Plage de puissance:	X.X - XX.X kW	
CO (13% O <sub>2</sub> ):	X.X% / XXXX mg/Nm <sup>3</sup>	
Dust / Poussière:	XX.X mg/Nm <sup>3</sup>	
Flue gas temperature / Température des fumées:	XXX° C	
Efficiency / Rendement:	XX.X%	
<small>from the test in accordance with EN 13229</small>		
Testing laboratory indicator / No. d'identification du lab. d'essai:	1625	
Test standard / Essai suivant norme:	EN 13229:2006, A1:2003, A2:2004	
Heating element / Foyer:	EN 13229-WA	
VKF no. / No. AEAL:	XXXXX	
Multiple connections permitted only with a self-closing door	Le raccordement multiple n'est autorisé que pour des foyers à fermeture de porte automatique	
May only be operated as a temporary-burning fireplace and follow the manual	Foyer ne pouvant être utilisé qu'en feu intermittent (NT) Read / Lisez attentivement la notice d'utilisation	
Sole recommended fuel: Natural wood	Combustible agréé: Bois naturel	
Rüegg Cheminée AG CH-8126 Zumikon www.ruegg-cheminee.com		
Fireplace insert name		
Manufacturer's number	Date of manufacture	
No. de fabrication	XXXXX	dd.mm.yyyy

### 3.10. Operating elements

The overview shows a possible layout option for the operating elements. The number and the layout of the operating elements may vary depending on the model. Not all the operating elements mentioned need be present on your fireplace.

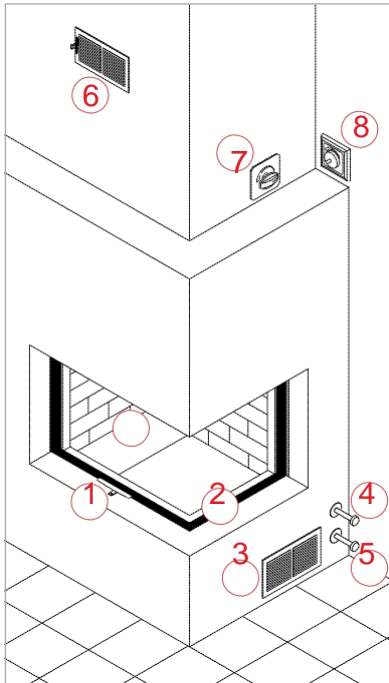

1. Air regulator
2. Fire door
3. Air grille – Ambient air inlet
4. Valve flap for combustion air
5. Valve flap for convection air
6. Air grille – Warm air outlet
7. Handle for flue gas flap
8. Regulator for fan

### 3.11. Fire door

The fire door on your fireplace can either be pushed up or swivelled open (swing out). It is constructed either as a single unit or in two parts, depending on the shape. The fire door consists of the following main components:

- Gasket
- Frame
- Ceramic glass
- Handle
- Hinge
- Locking mechanism

#### *Push up / push down*

The fire door can easily be pushed up and down by hand. Always hold the fire door firmly by the handle when pushing.

#### *Disengage/swivel open (swing out)*

Disengage the fire door as shown in the picture. Remove all objects from the swivel range and swing/swivel the fire door carefully outwards.

#### *Close (snap shut)/engage*

Remove all objects from the swivel range and close/snap the fire door carefully shut. The fire door locks automatically.

#### **Violino:**

View from the front

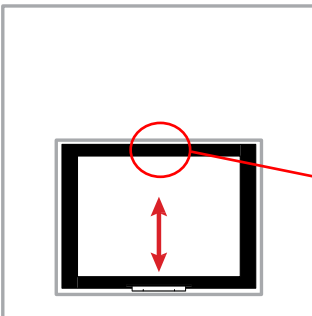

Locking detail

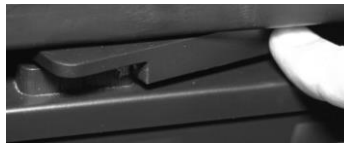

View from the side

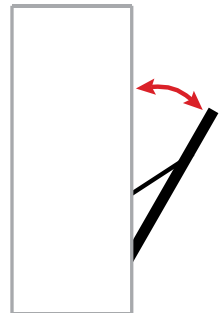

#### **RII, RIII:**

View from the front

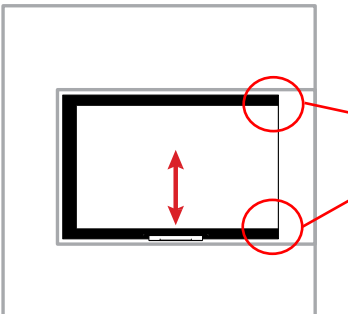

View from above



### 3.12. Air regulator

The supply of combustion air to the firebox is regulated with the air regulator. Depending on the operating condition, for ideal combustion more or less air must be supplied to the fire. The air regulator is variably adjustable. The symbol in the glass indicates in what setting more or less air is supplied.

Move the air regulator manually to the desired position.

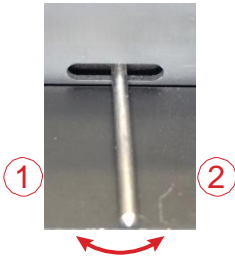

1. CLOSED
2. OPEN

### 3.13. Flue gas valve

The flue gas discharge is regulated in the flue gas system using the flue gas valve. The flue gas valve must always be open during the operation. The flue gas valve is variably adjustable. If there is a strong draught in the flue gas system the flue gas valve can be closed slightly and the draught restricted in this way. The symbol on the twist grip indicates the position the flue gas valve is in.

Move the grip to the desired position by hand.

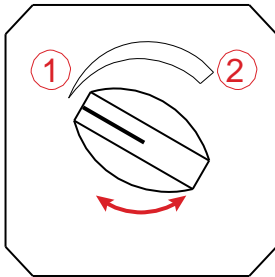

1. CLOSED
2. OPEN

### 3.14. Valves for combustion air/convection air

Depending on your fireplace's design, one or two air valves may be fitted close to the external facade. The one valve opens and closes the supply of combustion air. The other valve opens and closes the supply of convection air. The settings of the valves are controlled by separate gate valves. The valves *must* always be *fully open* when the fireplace is in operation. To avoid thermal bridges, the valves must be closed when the fireplace is being used.

Pull or push the gate valve into the desired position by hand.

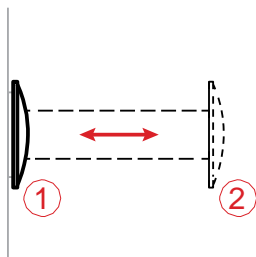

1. CLOSED

2. OPEN

### 3.15. Air grille

Air grilles, whose purpose is to circulate air, may be fitted to the casing of your fireplace. Ambient air enters the fireplace casing through the bottom air grille and the heated air escapes through the top air grille into the installation room. The air grilles can be *lockable* or *not lockable*, depending on the design. The valves must always be *fully open* when the fireplace is being used.

Open or close the air grille on the corresponding gate valve.

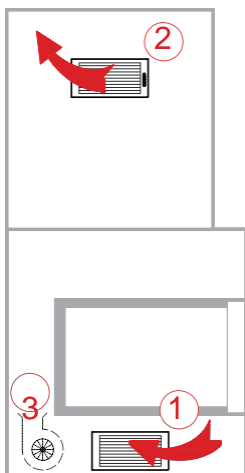

1. Air grille INLET

2. Air grille EXIT

3. Regulator (optional)



The air grilles are fixed into the casing with clamping plates. If necessary, you can remove the air grille by pulling it out and fit it again by pushing it back in.

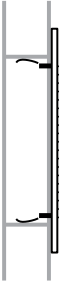

### 3.16. Fan

Depending on the design, a fan can be fitted in the substructure to your fireplace or outside the casing. The fan increases the system's air flow and distributes the warmed air in the installation room by means of the air grilles. The speed of the fan can be variably adjusted by hand using the rotary control. The fan should always be switched on when the fireplace is being used. Turn the regulator to the desired position by hand.

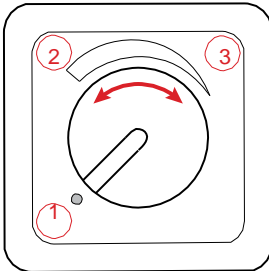

1. SWITCHED OFF
2. SWITCHED ON (large air flow)
3. SWITCHED ON (small air flow)

## 4. Information about safety

### 4.1. Safety spacing in the heat-radiation area

Flammable materials in the heat-radiation area of the fire door can be ignited. To avoid fires, keep the *safety spacing* of X [cm] between combustible materials and the fire door of your system.

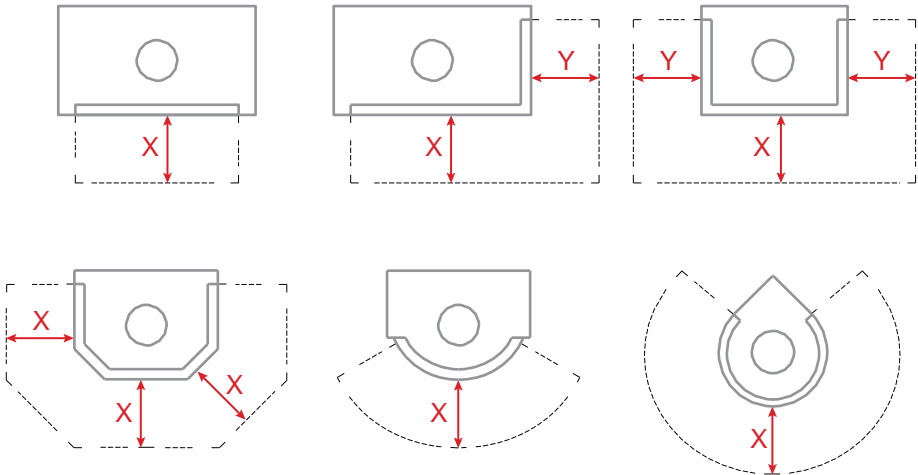

Appliance	X [cm]	Y [cm]
Violino 45x60	125	-
Violino 45x80	150	-
Violino 55x73	130	-
Violino 55x98	150	-
Violino 65x87	170	-
RIII 45x56x46	80	70
RIII 45x56x60	60	60
RIII 45x56x80	60	70
RIII 45x80x46	100	70
RIII 45x100x46	100	60
RIII 55x100x46	130	60

### 4.2. Air grille

Air grilles can be fitted in the casing depending on the type and function of your system. The convention air must be freely able to circulate through this air grille. Ensure that the air grilles are not closed or covered by any objects.

### 4.3. Precoat

Combustible floors must be protected around the fire doors by a *non-combustible precoat*. The precoat on your fireplace may not be removed.

#### **4.4. Fire door**

Your fire door is self-closing or not self-closing depending on the design. Self-closing fire doors have a safety function combined with other combustion units that are connected to the same chimney. No manipulation or changes to the fire door are permitted. Have the defective fire doors and gaskets repaired by the specialist installer straight away.

#### **4.5. Combustion air**

Depending on the type and function of your system the combustion air is fed into the system from the installation room (dependent upon ambient air) or from the outside (separated from ambient air). Ensure that sufficient ambient air can always flow in when several systems in a composite heating system are working simultaneously. Appliances that extract ambient air (extractor hoods, ventilation systems, central dust extraction units etc.) may not affect the operating safety of your system.

##### *System dependent upon ambient air*

Ensure that sufficient fresh air is always able to flow into the installation room.

##### *System separate from ambient air*

Ensure that the fresh air vent on the external facade or in the basement of the building is neither closed nor covered by any objects.

#### **4.6. Responsibility to inspect**

Small children and young people can sustain severe burns on the surfaces from the system when it is hot.

Always supervise small children when the system is operating. Explain to young people the risk of burns from the fireplace when it is in use.

#### **4.7. Damage to the system**

Operating damaged or incomplete systems is not permitted!

Do not carry out repairs to your system yourself. Have the defective systems repaired immediately by the specialist installer.

#### **4.8. Changes to the system**

Unauthorised changes to your system or individual parts are not permitted.

The manufacturer must always authorise any changes to the fireplace insert. Have any changes to your system carried out by the specialist installer.

#### **4.9. Care and maintenance**

Support the long-standing and safe operation of your system with a little maintenance and care.

Clean your system regularly and have it checked periodically by a specialist.

#### **4.10. Chimney fire**

In very rare cases, a chimney fire can occur. Do not try to extinguish it with water under any circumstances! Quickly expanding steam caused by the heat may damage your system!

##### **Possible causes of a chimney fire:**

- Burning fuels that are not permitted
- Inadequate cleaning of the flue gas system
- System has been out of service for several years

##### **How to recognise a chimney fire:**

- Flames from the chimney mouth
- Significant flying sparks
- Strong smoke and odour pollution
- External surface of the chimney is hot

##### **Take the following measures:**

- Close all air feeds into the systems
- Evacuate people and animals from the building
- Alert the fire brigade
- Allow the chimney to burn out
- Have the chimney checked by a specialist

## 5. Fuel

For a safe and environmentally friendly operation you may only burn the following permitted fuels in your fireplace:

### Fire lighters



### Firewood



### Briquettes



### 5.1. Forbidden fuels

Burning non-permitted materials is *forbidden* and *dangerous*. Do not burn the following materials in your fireplace:

- Damp and treated wood
- Flammable liquids
- Explosive materials
- Domestic and kitchen waste
- Electronic devices and components
- Plastics and rubber
- Medicaments and chemicals
- Textiles and shoes
- Newspapers and cardboard
- Animal carcasses
- Wood chips and pellets
- etc.

### 5.2. Flammable and explosive materials

Flammable materials may ignite when exposed to naked flames and hot surfaces.

Do not store any combustible or explosive materials *in the installation room* of your fireplace and around the *fresh air vent* on the external facade or in the basement of the building.

### 5.3. Firewood sizes

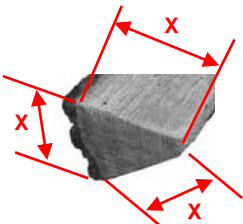

The fireplaces have been developed and tested for standardised sizes of firewood. These dimensions achieve an optimum burn with high heat propagation, low emissions, low pane contamination and lower wood consumption. Logs of other sizes can dirty the valves, affect emissions and heat propagation. The log must be cut into a minimum of 2 pieces and have an edge length **X** of approximately 7 cm. This gives a circumference of approximately 21 cm. Moisture of the wood should be 10-15%.

## 6. Information about operation

### ⚠ WARNING



#### Risk of fire!

Flammable materials may ignite when exposed to naked flames and hot surfaces.

- Do not store combustible materials close to the fireplace
  - Maintain a safe distance from the system
- 
- 

### ⚠ WARNING



#### Forbidden fuels!

The use of forbidden fuels may cause toxic flue gas emissions and damage to the system.

- Use only the permitted fuels
  - Do not exceed the maximum loading quantity
- 
- 

### ⚠ WARNING

#### Flue gases!

Flue gases can escape into the installation room through an open or badly sealed fire door.

- Always close fire door
  - Have defective seals replaced straight away
- 
- 

### ⚠ VORSICHT



#### Hot surfaces!

Contact with hot surfaces may result in severe burns.

- Constantly supervise small children
  - Explain the dangers to young people
  - Do not touch hot surfaces
  - Use safety gloves
- 
-

## 7. Commissioning

Take your system into service for the first time in conjunction with a specialist installer. He will explain in detail the functions and how to handle the operating elements. The materials of the casing must be *completely dry* during initial commissioning. Increase the volume of fuel added to the maximum quantity in *three steps*.

---

### HINWEIS

#### Foreign odours!

The colour of the fireplace insert must be fully baked in during the initial firings. This is why your system may give off unpleasant odours.

- Open all windows in the installation area
  - Close all doors in the installation area
- 
- 

### HINWEIS

#### Strange sounds!

Thermal expansion of the various materials on the fireplace insert may, in rare cases, result in cracking or ticking sounds as it heats up or cools down. These sounds are not dangerous and do not affect the operational safety and functionality of your system!

---

### 7.1. Complete combustion

Only ash remains behind in the firebox after complete combustion. Complete combustion of firewood is always divided into *three phases*.

#### Phase 1: *Drying out*

The residual humidity in the firewood evaporates at temperatures above 100°C.

#### Phase 2: *Outgassing*

The volatile elements of the firewood make up around 85% of the wood. These volatilise and ignite at temperatures above 230°C.

#### Phase 3: *Combustion*

The burning charcoal equates to around 15% of the energy content and burns without any visible flame at temperatures above 800°C.

## 7.2. Reduce harmful substances

Make an active contribution to *reducing harmful emissions* with a little effort. The most important measures here are:

- Fire with top-down combustion
- Use permitted fuels
- Keep to the maximum feed quantity
- Burn several smaller logs instead of one large log
- Adjust the operating elements to the particular operating state

## 7.3. Firing module

A firing module forms the basis for firing with *top-down combustion*. The fire burns out from the top down. Harmful emissions are greatly reduced during fire-up using this method. The overall quantity should not exceed the permitted loading quantity. Assemble the firing module as follows:

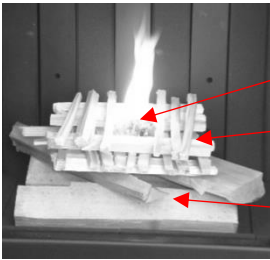

Firelighter

Fir (200-400 g)

Hardwood cross stack



## 7.4. Putting on wood

Each appliance has a different firebox and therefore different flow relationships. To achieve the correct combustion with good emissions the wood must be placed in the appliances in the following way.

### *Violino 45x80, 55x73, 55x98, 65x87*



### *Violino 45x60*



### *RIII 55x100x46, 45x100x46, 45x80x46*



### *RIII 45x56x46, 45x56x60, 45x56x80*



## 7.5. Effect of weathering

In rare cases, external temperatures over 15°C can result in a blockage in the flue gas system. As the temperature difference between the flue gas system and the external air is too low, too little discharge pressure is built up in the flue gas channel. The flue gases are not dissipated. A so-called *pilot fire*, which produces a great deal of heat in a short time, can under some circumstances clear the blockage.

Proceed as follows:

1. Fully open the flue gas valve
2. Loosely roll together 2 to 4 sheets of newspaper
3. Open fire door
4. Ignite newspaper and hold in the smoke outlet

If the blockage is not cleared despite several pilot fires, you should refrain from starting a fire in the fireplace. In areas with frequent severe weather conditions, installing a *flue gas fan* can provide a remedy.

## 7.6. Preparing the system

Proceed in the specified sequence when preparing your system.

1. Remove cold ash from the firebox (see Section 9)
2. Clean ceramic glass
3. Prepare the fuel
4. Set up firing module
5. Fully open combustion air valve
6. Fully open flue gas valve
7. Ensure there is a supply of combustion air
8. Fully open air grille on the casing

## 7.7. Fire

Proceed in the above sequence when *firing*:

1. Check the correct setting of all operating elements (if available on your system).
2. Switch off any mechanisms that extract ambient air (extractor hoods, ventilation systems, central dust evacuation units etc.).
3. Open the fire door.
4. Ignite the firelighter on the firing module with a match or a lighter.
5. Close the fire door.

Operating element		open	closed
Flue gas valve	(optional)	x	–
Combustion air valve	(optional)	x	–
Convection air valve	(optional)	x	–
Air grille	(optional)	x	–
Air regulator		x	x
Fan	(optional)		– Off –

## 7.8. Loading in fuel

Proceed in the following order *when loading in fuel*.

1. Check the correct setting of all operating elements (same setting as firing).
2. Open the fire door.
3. Load in the permitted quantity of fuel.
4. Close the fire door.

## 7.9. Firing with full load

Set the operating elements as follows *with full load* when *firing*:

Operating element		open	closed
Flue gas valve	(optional)	1/2	–
Combustion air valve	(optional)	x	–
Convection air valve	(optional)	x	–
Air grille	(optional)	x	–
Air regulator		1/2	–
Fan	(optional)	– On –	

The settings may vary depending on the system and the weather. Contact our specialist installer for the optimal setting for your system.

## 7.10. Firing with a light load

When firing with a light load the operating elements should be set in such a way that the *glow* in the firebox is *maintained* for as long as possible. This allows the residual heat to be used in a sensible way as far as energy is concerned. This operating state is generally produced at the end of a firing cycle before the system is taken out of service.

### **▲ VORSICHT**

#### **Danger of muffled explosion!**

If the operating elements are set to *light load* too early, this can result in a lack of oxygen in the firebox. A sudden inflow of air can cause a muffled explosion and damage the system.

- Adjust the operating elements only if no *naked flames* have been visible for more than five minutes.
- Do not open the fire door if you suspect a lack of oxygen.
- If you suspect a lack of oxygen open the air regulator slowly and in several stages.

Set the operating elements as follows *with light load* when *firing*:

Operating element		open	closed
Flue gas valve	(optional)	–	x
Combustion air valve	(optional)	–	x
Convection air valve	(optional)	–	x
Air grille	(optional)	x	–
Air regulator		–	x
Fan	(optional)	– Off –	

## 8. Closing down

### ▲ VORSICHT

#### Danger of muffled explosion!

If the operating elements are set to *light load* too early, this can result in a lack of oxygen in the firebox. A sudden inflow of air can cause a muffled explosion and damage the system.

- Adjust the operating elements only if no *naked flames* have been visible for more than five minutes.
- Do not open the fire door if you suspect a lack of oxygen.
- If you suspect a lack of oxygen open the air regulator slowly and in several stages.

Set the operating elements as follows on the *system that has cooled down*:

Operating element		open	closed
Flue gas valve	(optional)	–	x
Combustion air valve	(optional)	–	x
Convection air valve	(optional)	–	x
Air grille	(optional)	–	x
Air regulator		–	x
Fan	(optional)		– Off –

### 8.1. Malfunctions

Malfunctions may occur to your system in rare cases. The following table gives an overview of possible causes and remedial action. Inform your specialist installer if the remedial action has been unsuccessful.

**Fault:** Flue gas is not diverted off properly through the chimney.

**Possible causes:**

- Is the flue gas valve closed?
- Too little combustion air?
- Negative pressure in the installation area?

**Remedial action:**

- Open flue gas valve
- Open air regulator
- Open combustion air valve
- Open or tilt windows

**If unsuccessful**

- Allow fire to go out
- Check cooled-down system

**Fault:** Even after several combustions the casing does not get really warm.

**Possible causes:**

- Is the fuel quantity correct?
- Combustion and flame pattern correct?
- Is too much heat being lost through the chimney?

**Remedial action:**

- Load in the right quantity of fuel
- Adjust air regulator
- Close the flue gas valve further

**If unsuccessful**

- Allow fire to go out
- Check cooled-down system
- Inform specialist installer

**Fault:** Fire burns out very quickly and uncontrolled.

**Possible causes:**

- Is the air regulator open?
- Is the flue gas valve fully open?
- Is the fire door open?

**Remedial action:**

- Reduce air regulator
- Reduce flue gas valve
- Close fire door

**If unsuccessful**

- Check cooled-down system
- Inform specialist installer

**Fault:** Fire burns poorly and smoulders

**Possible causes:**

- Too little combustion air?
- Is the flue gas valve closed?
- Wrong fuel?
- Is the fuel quantity correct?
- Are the logs too big?
- Is the wood too wet?
- Too little starter firewood?

**Remedial action:**

- Open air regulator
- Open flue gas valve
- Use permitted fuels
- Load on fuel in the permitted quantity
- Load on several small logs

**If unsuccessful**

- Allow fire to go out
- Check cooled-down system
- Inform specialist installer

**Fault:** Ceramic glass on the fire door rusts over very quickly.

**Possible causes:**

- Too little combustion air?
- Is the flue gas valve closed?
- Wrong fuel?
- Is the fuel quantity correct?
- Are the logs too big?

**Remedial action:**

- Open air regulator
- Open flue gas valve
- Use permitted fuels
- Load on fuel in the permitted quantity
- Load on several small logs

**If unsuccessful**

- Inform specialist installer

**Fault:** Unpleasant foreign odours in the installation room.

**Possible causes:**

- Are there any objects on the casing or in the heat-radiation area?
- Is there any dust on the casing or in cavities?
- Have more than three firing intervals already been carried out?

**Remedial action:**

- Remove objects
- Clean casing and cavities
- Burn in paint at high temperature

**If unsuccessful**

- Allow fire to go out
- Check cooled-down system
- Inform specialist installer

## 9. Information about care and maintenance

Regular cleaning and maintenance of the components promotes operational safety and increases your system's service life.

---

### ▲ VORSICHT



#### Hot surfaces!

Contact with hot surfaces may result in severe burns.

- Carry out cleaning, inspection or maintenance work to the cooled-down system
- 

### ▲ WARNUNG



#### Risk of fire!

Embers can remain in the ashes over several days and cause a fire.

- Allow ashes to cool completely
  - Fill fireproof containers with ash
- 

### HINWEIS

#### Ceramic glass

Unsuitable liquids and cleaning agents will damage the surface of ceramic glass.

- Use only permitted liquids and cleaning agents
  - Follow maintenance information
-

## 9.1. Cleaning

Clean the following components regularly and as described:

### **Ceramic glass**

The ceramic glass can be cleaned either *dry* or *damp*. A special sponge is used for dry cleaning and the special Rüegg ceramic cleaner for damp cleaning.



Fig. 15: Permitted cleaning agent

Provide the following for cleaning:

- Special sponge or Rüegg ceramic class cleaner
- Old newspaper
- Dry paper towels
- Wetted paper towels

Proceed in the above order when *dry cleaning*:

1. Disengage and swivel out/open fire door → see Section 3
2. Clean the inside of the ceramic glass with a special sponge
  - use the *rough side* if heavily soiled
  - use the *smooth side* if slightly soiled
3. Repeat cleaning operation until ceramic glass is clean
4. Disengage and swivel out/close fire door → see Section 3

Proceed in the above order when *damp cleaning*:

1. Disengage and swivel out/open fire door → see Section 3
2. Protect chimney bank and floor with newspaper
3. Lightly spray *inside of ceramic glass with* Rüegg ceramic glass cleaner
4. Leave ceramic glass cleaner several minutes to take effect
5. Wipe off the inside with dry paper towels
6. Repeat cleaning operation until ceramic glass is clean
7. Wipe down the inside with damp paper towels
8. Disengage and swivel out/close and engage fire door → see Section 3

9. Lightly spray *outside of ceramic glass* with Rüegg ceramic glass cleaner
10. Wipe down the inside with dry paper towels
11. Repeat cleaning operation until ceramic glass is clean
12. Wipe down the inside of ceramic glass with damp paper towels
13. Disengage and swivel out/close and engage fire door → see Section 3

### **Firebox**

Remove the *completely cooled ashes* regularly from the firebox. To do this, either use a conventional ash vacuum cleaner or a hand brush with metallic dustpan. Place the ashes into a *sealable, fireproof container* and dispose of this, if necessary, together with your household waste. Please follow the local regulations if you do.

Provide the following for cleaning:

- Sealable, fireproof container
- Ash vacuum cleaner or dustpan with hand brush

Proceed in the above order when cleaning:

1. Push up fire door → see Section 3
2. Remove ash from the fire floor
3. Close fire door → see Section 3

### **Air grille**

Over time, dust can collect on the air grilles and in the cavities behind. The convection air that circulates during the operation moves the dust in the installation area. Improve the indoor climate in the installation area by regularly cleaning the air grille and cavities.

Provide the following for cleaning:

- Vacuum cleaner

Proceed in the above order when cleaning:

1. Remove air grille → see Section 3
2. Clean cavity with vacuum cleaner
3. Clean air grille with vacuum cleaner
4. Fit air grille → see Section 3

Caution: Do not allow any foreign bodies to get into the hot air chambers. They may ignite or cause negative or harmful odours to develop over time. Have any objects removed by a specialist before using the system.



### ***Air fitting***

In systems that are separated from ambient air, the air fitting for the combustion air and/or convention air can either be fitted on the ceiling/wall of the room in the basement or on the external facade of the building. To ensure the system works properly, the air fittings must always be kept clean. Free any air fittings fitted to the external facade from any overgrowing plants and regularly clean all air fittings.

Provide the following for cleaning:

- Garden shears
- Vacuum cleaner

Proceed in the above order when cleaning:

1. Cut back plants
2. Remove air grille → see Chapter 3
3. Clean pipe with vacuum cleaner
4. Clean air grille with vacuum cleaner
5. Fit air grille → see Section 3

### ***Flue gas system***

Soot and flue gas particles are deposited in the flue gas system. The flue gas system must be cleaned regularly to ensure it works properly and safely. Cleaning the flue gas system yourself is not permitted!

Always have the flue gas system cleaned by a *specialist expert*.

## **9.2. Checks**

Regularly check the system when cold.

... check that the air grille and air fitting are *clean* and have an *unobstructed cross section*.

... check the seal on the swivelled open fire door to ensure that it is *intact* and shows no *defects*.

... check the *draught* (the air circulation) in the chimney, in particular after the system has not been used for a while.

## **9.3. Maintenance**

Your system is generally maintenance free. You can clean the system when cold with a clean cloth and then carefully spray with WD40 multispray, if necessary.

## 9.4. Repair

Operating defective or incomplete systems is not permitted!

Replace defective wall and floor components of the firebox casing as described in Section 5.8. To supply the correct spare parts, we need the details about the device type and the production date as shown on the type plate in Section 5.9.

Inform your specialist installer if...

- ... the flue gas valve is blocked.
- ... the air valve for combustion air is blocked.
- ... the air valve for convection air is blocked.
- ... the gasket on the fire door is defective or incomplete.
- ... the fire door is blocked.
- ... the locking mechanism to the fire door is defective.
- ... the fan for convection air is defective.
- ... you do not intend to replace wall or floor parts in the firebox casing yourself.

## 9.5. Spare parts

Moving parts and gaskets wear during use. How quickly a component is worn is determined primarily by the frequency and intensity of use. The components in your fireplace insert are designed for a long service life.

Please contact your specialist installer in the event of any damage. They will be happy to advise you and help you further. Always use the recommended *original spare parts*. Other parts may damage your system and impair operational safety.

## 9.6. Warranty conditions

Please contact your specialist installer in the event of any damage. They will examine any potential warranty claim with us and arrange for any further action to be taken. A claim may be made against the guarantee only if the Rüegg warranty certificate has been completed in full and sent to the following address:

Rüegg Cheminée Schweiz AG  
Studbachstrasse 7  
8340 Hinwil  
Switzerland



