

Einbaurahmen / Cadre de montage Telaio per il montaggio / Mounting frame

Frontansicht / Vue de face
Vista frontale / Front view

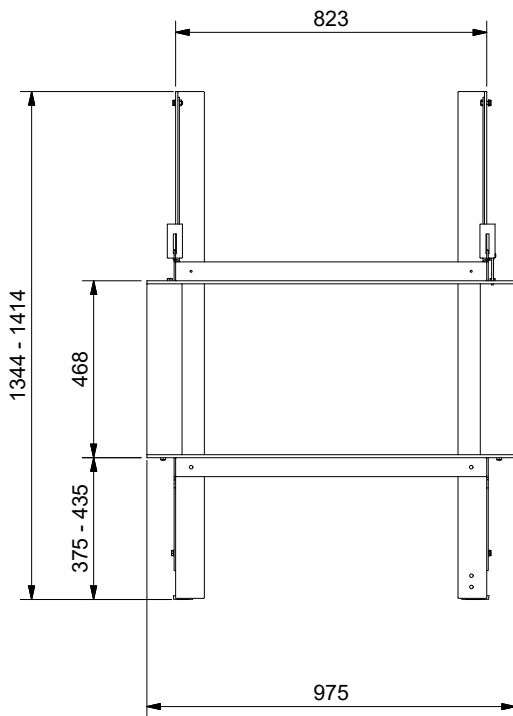

Seitenansicht / Vue de coté
Vista laterale / Side view

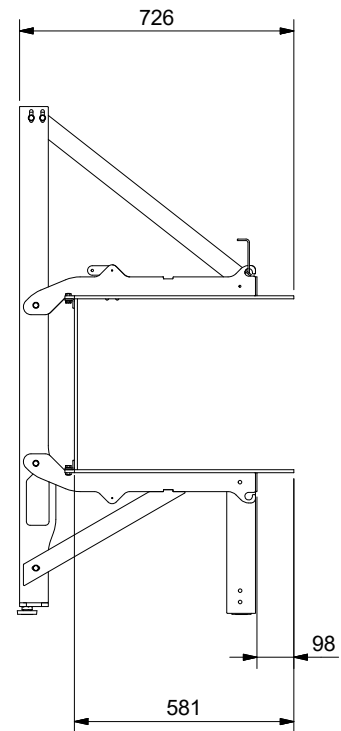

Aufsicht / Vue de haut
Vista dall'alto / View above

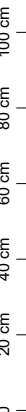
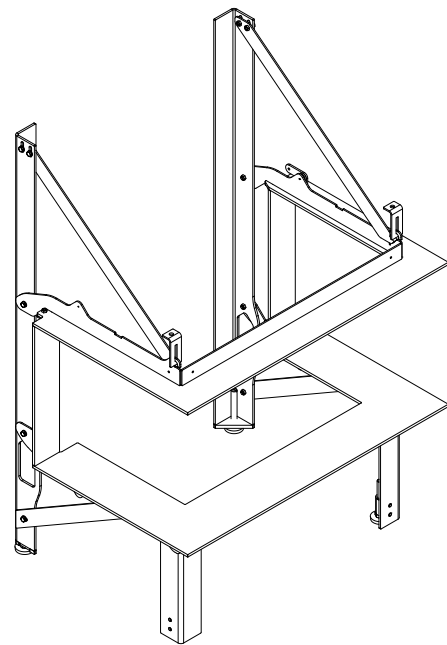
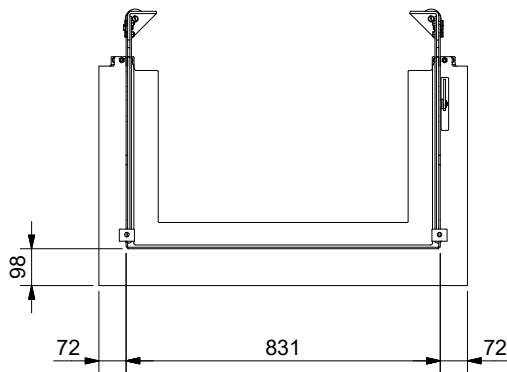

Allgemeintoleranz / Tolerance générale / Tolleranza generale / Tolerance general ± 2 mm

Detailansichten durch Zoom-Funktion auf dem elektronischen pdf-Massblatt ersichtlich. Download unter www.ruegg-cheminee.com.
La vue détaillée est visible par la fonction zoom sur la fiche de mesure pdf. Download voir sous voir sous www.ruegg-cheminee.com.
La vista dettagliata é resa possibile tramite la funzione "Zoom" sulla scheda tecnica in pdf. Scaricabile dal sito www.ruegg-camini.it.
Detailed views of zoom function on the electronic PDF datasheet apparent. Download at www.ruegg-cheminee.com.

Alle Masse in mm! Massänderungen vorbehalten / Dimensions en mm! Sous réserve de modifications / Tutte le misure indicate sono in mm! Con riserva di modifica / All dimensions in mm! Mass change without notice

Typ	RIII 45x80x46 Gen.1		Massblatt Fiche de mesure Scheda tecnica Dimensional drawing	Massstab Echelle Scala Scale
Art. Nr.	12.70.2017-00321	Status	Freigegeben	1:20
	Rüegg Cheminée AG Schwäntemos 4 CH-8126 Zumikon	Tel. : +41 (0)44 919 82 82 Fax. : +41 (0)44 919 82 90 www.ruegg-cheminee.com	Projektionsmethode 	Zeichnungs Nr. 2017-00370
				Revision -